

**3 Volt Voltage Variable Absorptive Attenuator**  
**40 dB, 0.5-2.0 GHz**

**AT-113**  
**V5**

**Features**

- Single Positive Voltage Control: 0 to +3 Volts
- 40 dB Attenuation Range at 0.9 GHz
- $\pm 2$  dB Linearity from BSL
- Low DC Power Consumption
- SOIC-8 Plastic Package
- Tape and Reel Packaging Available

**Description**

M/A-COM's AT-113 is a GaAs MMIC voltage variable absorptive attenuator in a low-cost SOIC 8-lead surface mount plastic package. The AT-113 is ideally suited for use where linear attenuation fine tuning and very low power consumption are required.

Typical applications include radio, cellular, GPS equipment and automatic gain/level control circuits.

The AT-113 is fabricated with a monolithic GaAs MMIC using a mature 1-micron process. The process features full chip passivation for increased performance and reliability.

**Functional Schematic** <sup>1,2,3,4</sup>

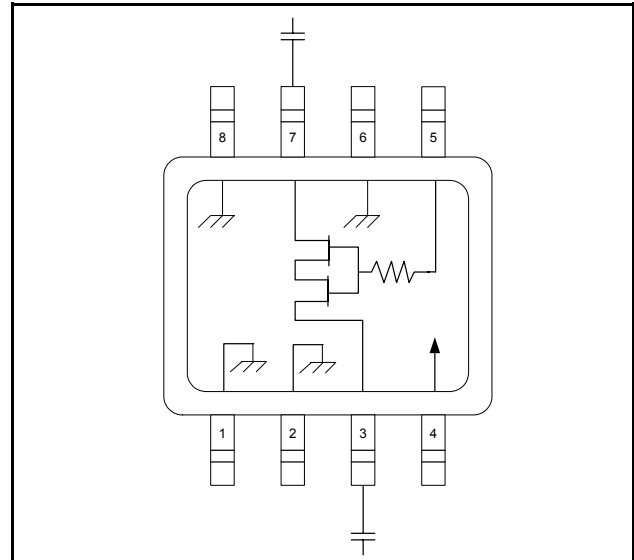

1.  $V_{CC} = +3$  VDC @ 50  $\mu$ A maximum.
2.  $V_C = 0$  VDC to +3 VDC @ 50  $\mu$ A maximum.
3. External DC blocking capacitors are required on all RF ports.
4. 39 pF used for data measurements.

**Ordering Information**

Part Number	Package
AT-113	SOIC 8-Lead Plastic Package
AT-113TR	Forward Tape and Reel

Note: Reference Application Note M513 for reel size information.

**Pin Configuration**

Pin No.	Function	Pin No.	Function
1	Ground	5	$V_C$
2	Ground	6	Ground
3	RF Port	7	RF Port
4	$V_{CC}$	8	Ground

**Absolute Maximum Ratings** <sup>5</sup>

Parameter	Absolute Maximum
Input Power	+21 dBm
Supply Voltage $V_{CC}$	$-1 \text{ V} \leq V_{CC} \leq +8 \text{ V}$
Control Voltage $V_C$	$-1 \text{ V} \leq V_C \leq V_{CC} + 0.5 \text{ V}$
Operating Temperature	$-40^\circ\text{C}$ to $+85^\circ\text{C}$
Storage Temperature	$-65^\circ\text{C}$ to $+150^\circ\text{C}$

5. Exceeding any one or combination of these limits may cause permanent damage to this device.

**3 Volt Voltage Variable Absorptive Attenuator**  
**40 dB, 0.5-2.0 GHz**

**AT-113**  
**V5**

**Electrical Specifications<sup>6</sup>: T<sub>A</sub> = 25°C, Z<sub>0</sub> = 50 Ω**

Parameter	Test Conditions	Units	Min	Typ	Max
Insertion Loss	0.5 - 1.0 GHz	dB	—	2.7	3.0
	1.0 - 2.0 GHz	dB	—	3.0	3.5
Attenuation	0.5 - 1.0 GHz	dB	40	—	—
	1.0 - 2.0 GHz	dB	35	—	—
Flatness (Peak to Peak)	0.5 - 1.0 GHz	dB	—	± 0.5	± 0.8
	1.0 - 2.0 GHz	dB	—	± 1.2	± 1.5
VSWR	—	Ratio	—	2:1	—
Trise, Tfall	10% to 90% RF, 90% to 10% RF	µS	—	10	—
Ton, Toff	50% Control to 90% RF, 50% Control to 10% RF	µS	—	12	—
Transients	In-band	mV	—	10	—

6. The RF ports must be blocked outside of the package from ground or any other voltage.

**SOIC-8**

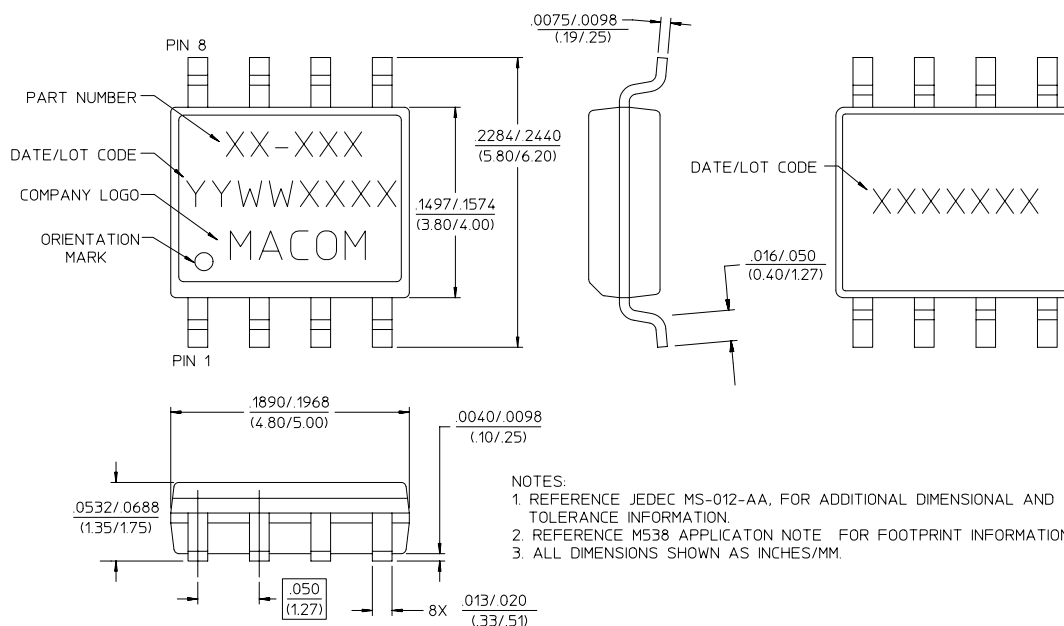

**3 Volt Voltage Variable Absorptive Attenuator  
40 dB, 0.5-2.0 GHz**

**AT-113  
V5**

**Typical Performance Curves @ 25°C**

**Attenuation vs. Control Voltage**

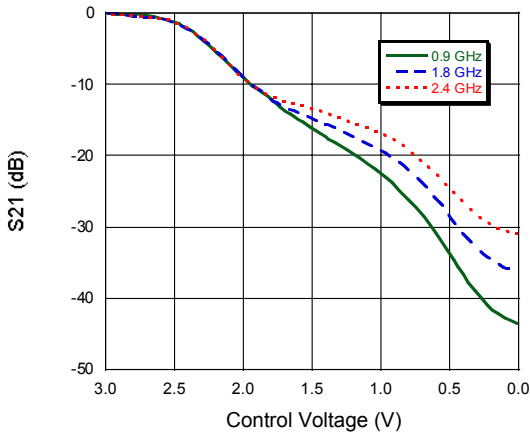

**Attenuation vs. Frequency @ 0V**

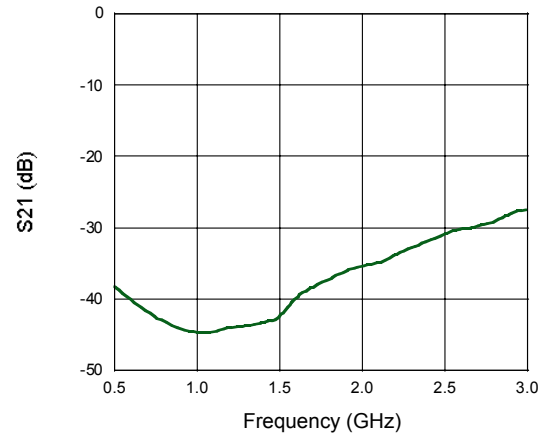

**Insertion Loss vs. Frequency**

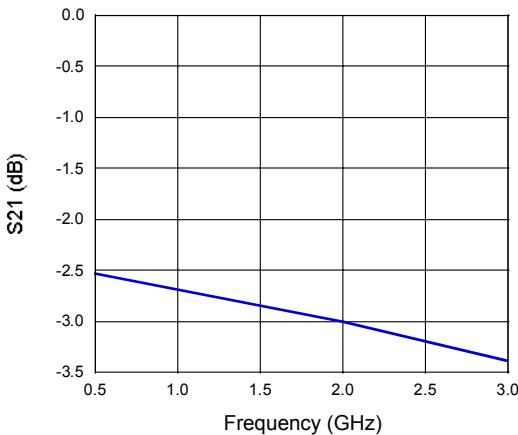

**Return Loss vs. Control Voltage  
F = 900 MHz**

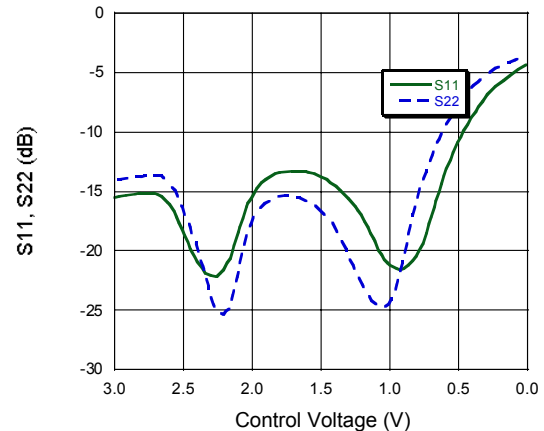

**1 dB Compression vs. Control Voltage**

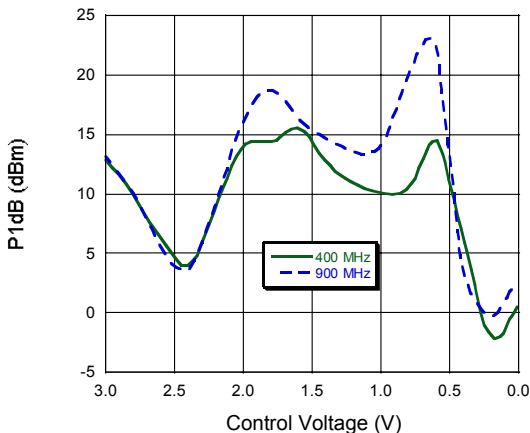

**IP3 vs. Control Voltage**

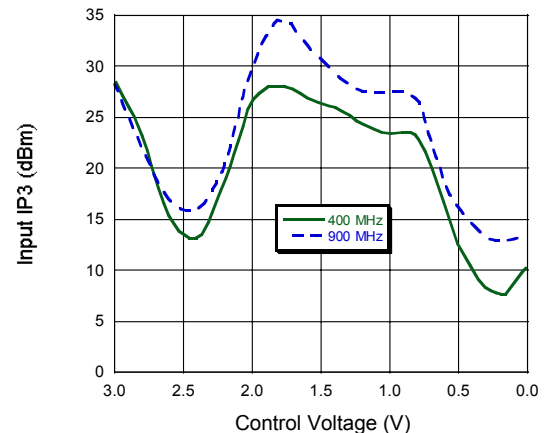

**Typical Performance Curves**

*Attenuation vs. Temperature*  
*Normalized @ 25°C, F = 900 MHz*

